













Dati Tecnici - Specifications

	 cond	 comp. W	 ABS. W	 Fuse	 Kwh/100Kg	 I / h	 kg	 Lbs	 kg	 Lbs
NU 270 A		3304	1200	10	12.7	10	78	172	87	192
NU 270 W		3304	1200	10	9.6	136	78	172	87	192



Produzione Ghiaccio - Ice Production

Raffreddamento ad aria - Air Cooled Unit

Temp. Aria Air Temp.	Temp. Acqua / Water Temp.				
					
°C	32°	21°	15°	10°	
°F	90°	70°	60°	50°	
10°					320
50°					705
21°					310
70°					683
32°		220			
90°		485			
38°					
100°					

Raffreddamento ad acqua - Water Cooled Unit

Temp. Aria Air Temp.	Temp. Acqua / Water Temp.				
					
°C	32°	21°	15°	10°	
°F	90°	70°	60°	50°	
10°					305
50°					672
21°					290
70°					639
32°		240			
90°		529			
38°					
100°					



PANNELLO DI CONTROLLO - CONTROL PANEL





DEPOSITO - SLOPE BIN

D105-D155-D205-D255-D305-D405-D505

DIMENSIONI - DIMENSIONS

LxPxH (mm)

	538 x 663 x 645
	21" 3/16 x 26" 2/16 x 25" 6/16
	610 x 760 x 820
	24" x 29" 15/16 x 32" 5/16

TIPO GHIACCIO - ICE TYPE

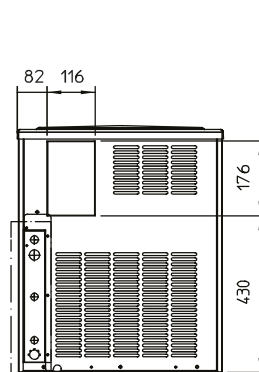
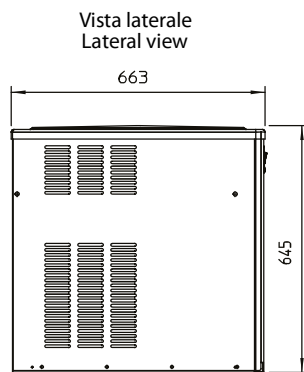
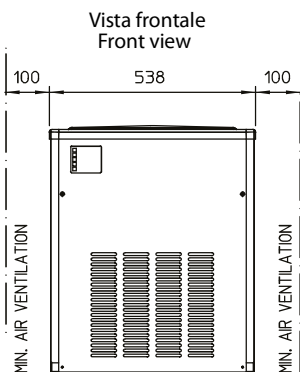

Vista superiore Top view

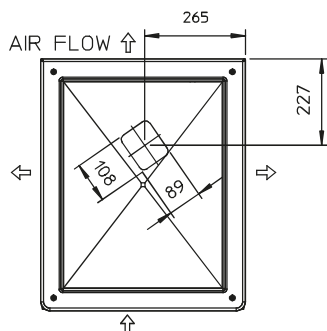

UNITÀ DI MISURAmm

- Ø 21 mm SCARICO ACQUA
- 3/4" GAS - ENTRATA ACQUA
- 3/4" GAS - SCARICO ACQUA SOLO RAFFREDD. ACQUA
- 3/4" GAS - ENTRATA ACQUA SOLO RAFFREDD. ACQUA
- CAVO DI ALIMENTAZIONE

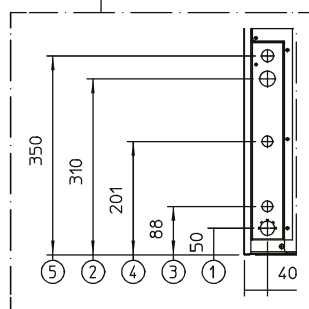





CONDIZIONI USO-OPERATING REQUIREMENTS



230/50/1



R452A GWP = 2141

MIN		MAX
10°C (50°F)		40°C (104°F)
5°C (41°F)		35°C (95°F)
- 10 %		+ 10 %
1 Bar (14 psi)		5 Bar (70 psi)